



nova *line*

News

Marzo 2024



LED Bulkhead



Consumer Line

Struttura e diffusore in policarbonato (PC)

Polycarbonate (PC) body and diffuser

Assenza rischi fotobiologici

No photobiological risk

EN 62471

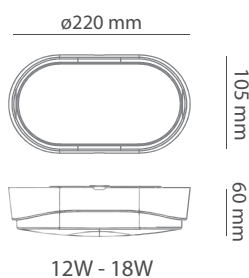
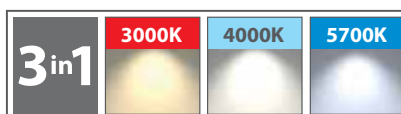

| Codice | Potenza | Tensione | Corrente | CCT | Lumen | Modulo Led | Imballo/Pz | 8028274 |
|---------------|---------|-----------|----------|-----------------|-------------------|-------------------|-------------|-----------|
| Code | Wattage | Voltage | Current | CCT | Lumen | Led module | Pcs/ Carton | Ean Code |
| BV60X | 12W | 220-240 V | 81 mA | 3000/4000/5700K | 1218/1273/1202 lm | 1398/1464/1382 lm | 20 | ...123425 |
| BV100X | 18W | 220-240 V | 117 mA | 3000/4000/5700K | 1788/2136/2012 lm | 2056/2458/2314 lm | 20 | ...123432 |

LED Bulkhead

Consumer Line

Struttura e diffusore in policarbonato (PC)

Polycarbonate (PC) body and diffuser

Assenza rischi fotobiologici

No photobiological risk

EN 62471

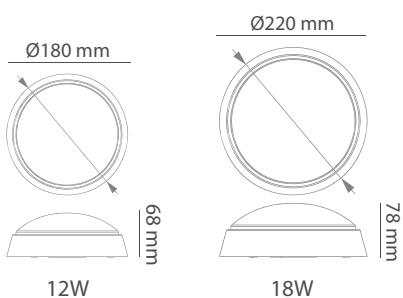
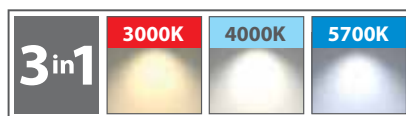

| Codice | Potenza | Tensione | Corrente | CCT | Lumen | Modulo Led | Imballo/Pz | 8028274 |
|---------------|---------|-----------|----------|-----------------|-------------------|-------------------|------------|-----------|
| Code | Wattage | Voltage | Current | CCT | Lumen | Led module | Pcs/Carton | Ean Code |
| BT75X | 12W | 220-240 V | 81 mA | 3000/4000/5700K | 1182/1268/1225 lm | 1359/1459/1409 lm | 20 | ...123449 |
| BT100X | 18W | 220-240 V | 116 mA | 3000/4000/5700K | 1608/1793/1589 lm | 1849/2075/1837 lm | 20 | ...123456 |

Sensor LED Bulkhead

Consumer Line

Struttura e diffusore in policarbonato (PC)

Polycarbonate (PC) body and diffuser

Assenza rischi fotobiologici

No photobiological risk

EN 62471

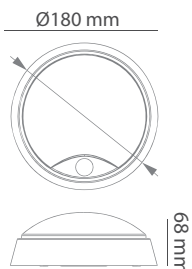
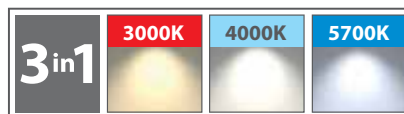

| Codice | Potenza | Tensione | Corrente | CCT | Lumen | Modulo Led | Imballo/Pz | 8028274 |
|--------|---------|-----------|----------|-----------------|-------------------|-------------------|------------|-----------|
| Code | Wattage | Voltage | Current | CCT | Lumen | Led module | Pcs/Carton | Ean Code |
| BTS90X | 15W | 220-240 V | 95 mA | 3000/4000/5700K | 1586/1747/1565 lm | 1824/2009/1800 lm | 20 | ...123463 |

Tri-White Led Step Light/Wall Light

Consumer Line



Struttura in policarbonato (PC)
Polycarbonate (PC) body

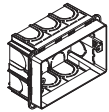

Compatibile con scatola da incasso standard 503
Compatible with standard 503 flush-mounted box

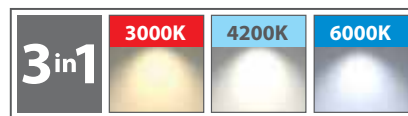
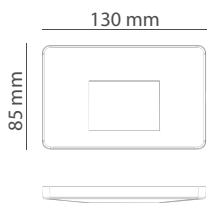

| Codice | Colore | Potenza | Tensione | Corrente | CCT | Lumen | Ra | Imballo/Pz | 8028274 |
|--------|--------|---------|-----------|----------|-----------------|-------|-----|------------|-----------|
| Code | Colour | Wattage | Voltage | Current | CCT | Lumen | Ra | Pcs/Carton | Ean Code |
| PL03WX | Bianco | 3W | 220-240 V | 23 mA | 3000/4200/6000K | 110lm | >80 | 20/100 | ...123654 |
| PL03BX | Nero | 3W | 220-240 V | 23 mA | 3000/4200/6000K | 110lm | >80 | 20/100 | ...123647 |

LED Flood Light



Consumer Line

Tecnologia SMD Led

SMD Led technology

Alluminio pressofuso

Diecast aluminium

Vetro temperato

Tempered glass

Assenza rischi fotobiologici

No photobiological risk

EN 62471



Fornito di connettore
waterproof
Waterproof connector
included

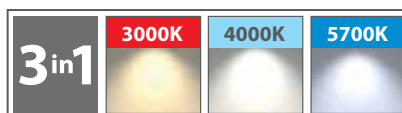

| Codice | Potenza | Tensione | Corrente | P.F. | CCT | Lumen | Modulo Led | Imballo/Pz | 8028274 |
|--------|---------|-----------|----------|------|-----------------|------------------|------------------|------------|-----------|
| Code | Wattage | Voltage | Current | P.F. | CCT | Lumen | Led module | Pcs/Carton | Ean Code |
| FKB20X | 20 W | 220-240 V | 93 mA | >0,7 | 3000/4000/5700K | 1637/1604/1592lm | 1801/1764/1751lm | 30 | ...123470 |
| FKB30X | 30 W | 220-240 V | 129 mA | >0,9 | 3000/4000/5700K | 2432/2750/2458lm | 2675/3025/2734lm | 20 | ...123487 |
| FKB50X | 50 W | 220-240 V | 223 mA | >0,9 | 3000/4000/5700K | 4248/4778/4019lm | 4673/5256/4421lm | 10 | ...123494 |

LED Flood Light

Consumer Line

Tecnologia SMD Led

SMD Led technology

Alluminio pressofuso

Diecast aluminium

Vetro temperato

Tempered glass

Assenza rischi fotobiologici

No photobiological risk

EN 62471

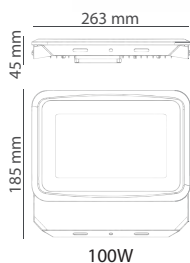
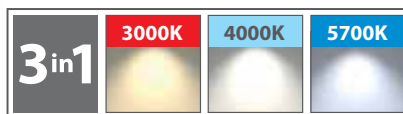

| Codice | Potenza | Tensione | Corrente | P.F. | CCT | Lumen | Modulo Led | Imballo/Pz | 8028274 |
|---------|---------|-----------|----------|------|-----------------|------------------|------------------|------------|-----------|
| Code | Wattage | Voltage | Current | P.F. | CCT | Lumen | Led module | Pcs/Carton | Ean Code |
| FKB100X | 100 W | 220-240 V | 435 mA | >0,9 | 3000/4000/5700K | 8188/8020/7962lm | 8720/9887/8543lm | 5 | ...123500 |
| FKW100X | 100 W | 220-240 V | 435 mA | >0,9 | 3000/4000/5700K | 8188/8020/7962lm | 8720/9887/8543lm | 5 | ...123517 |

LED Linear Light



Premium Line

Struttura in policarbonato

PC body

Assenza rischi fotobiologici

No photobiological risk

EN 62471

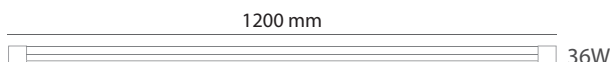
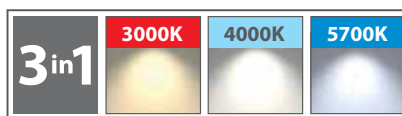

| Codice | Potenza | Tensione | Corrente | P.F. | Ra | CCT | Lumen | Imballo/Pz | 8028274 |
|----------------|---------|-----------|----------|------|-----|-----------------|------------------|-------------|-----------|
| Code | Wattage | Voltage | Current | P.F. | Ra | CCT | Lumen | Pcs/Cartron | Ean Code |
| RBA60X | 18W | 180-265 V | 129 mA | >0,7 | >80 | 3000-4000-5700K | 2130/2330/2084lm | 20 | ...122619 |
| RBA120X | 36W | 180-265 V | 153 mA | >0,9 | >80 | 3000-4000-5700K | 4052/4504/4083lm | 20 | ...122541 |

LED High Bay EMERGENCY KIT

Premium Line

Durata in emergenza: 3 ore

Emergency duration: 3 hours

Tempo di ricarica 4-5 ore

Charging Time 4-5h

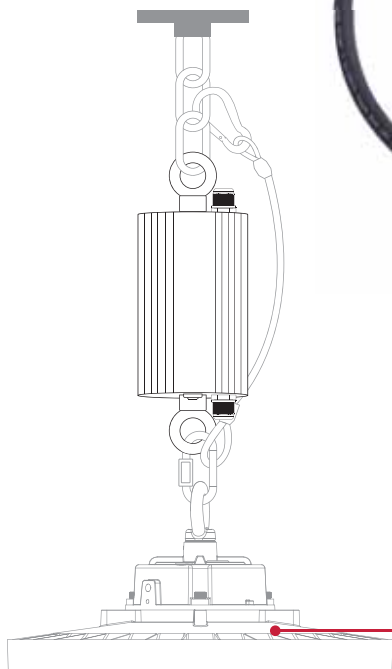

**Compatibile con i modelli
HBV100X e HBV200X**

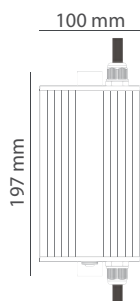

| Codice | Potenza | Tensione | Batteria | Durata | Tempo di ricarica | Imballo/Pz | 8028274 |
|-----------------|---------|-----------|--------------------|--------------|-------------------|-------------|-----------|
| Code | Wattage | Voltage | Battery | working time | Charging time | Pcs/ Carton | Ean Code |
| EMG25170 | 25W | 100-240 V | 18V 5000mAh Li-ion | 3h | 36h | 2 | ...123418 |

EMERGENCY Light



Premium Line

Modalità di funzionamento:

SE solo emergenza

Operation mode: Non-Maintained

Durata in emergenza: 3 ore

Emergency duration: 3 hours

**Colore bianco,
copertura trasparente**

White colour, clear cover

Vita Batteria – fino a 4 anni

Battery lifetime – up to 4 years

Assenza rischi fotobiologici

No photobiological risk

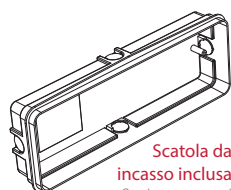

**Scatola da
incasso inclusa**
flush-mounted
box included

**Lampada d'emergenza
funzione Solo Emergenza.**
La lampada si accenderà
solo in caso di mancanza
della rete elettrica;
La lampada può essere in-
stallata a parete o incasso.

Non Maintained function
Emergency light.
Lamp will be turned on in
case of power failure only.
Emergency lamp can be
wall installed or recessed.

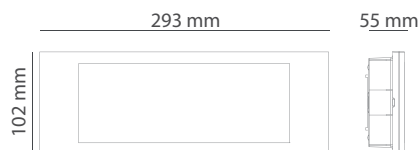

| Codice | Potenza | Tensione | Lumen | CCT | Batteria | Imballo/Pz | 8028274 |
|----------|---------|-----------|-------|-------|--------------------|------------|-----------|
| Code | Wattage | Voltage | Lumen | CCT | Battery | Pcs/Carton | Ean Code |
| EMG295SE | 5W | 220-240 V | 180lm | 6500K | Litio 3.7V 1800mAh | 20 | ...123630 |

LED Table Lamp



Consumer Line

Corpo in PS+ABS

PS+ABS body

36 LED luce bianca 3000-4000-6500K

36 x LED white light 3000-4000-6500K

Batteria 3,7V 800mAh agli ioni di litio

1 x 3,7V 800mAh Li-ion battery

Tempo di ricarica 1 ora

Charging Time 1h

Cavo di ricarica USB-C, 50 cm

50 cm Type C USB cable

Grado di protezione IP20

IP20 protection



Accessorio incluso
Cavo USB di tipo C da 50 cm
Accessory included
50 cm Type C USB cable

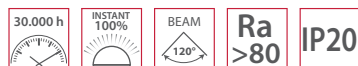
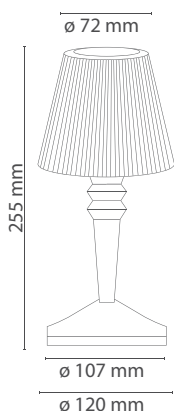

| Codice | Potenza | Batteria | CCT | Peso | Imballo/Pz | 8028274 |
|--------|---------|--------------------|-----------------|--------|------------|-----------|
| Code | Wattage | Battery | CCT | Weight | Pcs/Carton | Ean Code |
| LTA25T | 2W | 3,7V 800mAh Li-ion | 3000-4000-6500K | 333 g | 12 | ...122121 |

Rechargeable LED Table Lamp

Consumer Line



Corpo in metallo con verniciatura a polvere

Powder coated metal body

Controllo touch per funzione dimmer e cambio CCT

Touching function for dimmer and CCT change function

Batteria 3,7V 2000mAh agli ioni di litio

1 x 3,7V 2000mAh Li-ion battery

6 ore di durata

6 hours of duration

Tempo di ricarica 4 ore

Charging Time 4h

Cavo di ricarica USB-C, 100 cm

100 cm Type C USB cable

Grado di protezione IP44

IP44 protection



LTB36W



LTB36B



LTB36CR

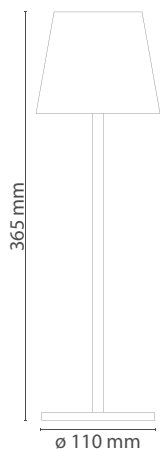

| Codice | Colore | Potenza | Batteria | CCT | Lumen | Imballo/Pz | 8028274 |
|---------|--------|---------|---------------------|-----------------|-----------|------------|-----------|
| Code | Color | Wattage | Battery | CCT | Lumen | Pcs/Carton | Ean Code |
| LTB36W | Bianco | 1,2W | 3,7V 2000mAh Li-ion | 2800/4500/6000K | Max 70 lm | 6 | ...124064 |
| LTB36B | Nero | 1,2W | 3,7V 2000mAh Li-ion | 2800/4500/6000K | Max 70 lm | 6 | ...124040 |
| LTB36CR | Corten | 1,2W | 3,7V 2000mAh Li-ion | 2800/4500/6000K | Max 70 lm | 6 | ...124057 |



LED Table Lamp

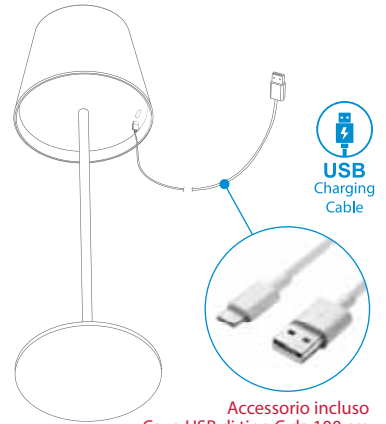

USB
Charging
Cable

Accessorio incluso
Cavo USB di tipo C da 100 cm
Accessory included
100 cm Type C USB cable

Alba

Rechargeable Led table lamp



Accessorio incluso
Cuneo/tappo bottiglia
Accessory included
Bottle wedge/cap



**MAKE
EVERY
BOTTLE
A LAMP**



Rechargeable LED Table Lamp

Consumer Line



Corpo in metallo con inserti in ecopelle

Metal body with eco-leather inserts

Controllo touch per funzione dimmer e cambio CCT

Touching function for dimmer and CCT change function

Batteria 3,7V 4000mAh agli ioni di litio

1 x 3,7V 4000mAh Li-ion battery

10 ore di durata

10 hours of duration

Tempo di ricarica 2-3 ore

Charging Time 2-3h

Cavo di ricarica USB-C, 100 cm

100 cm Type C USB cable

Grado di protezione IP20

IP20 protection



LTP35OC

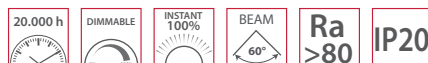
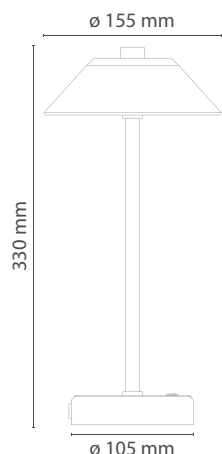

| Codice | Colore | Potenza | Batteria | Numero Led | Lumen | Imballo/Pz | 8028274 |
|---------|-------------|---------|---------------------|-----------------|------------|------------|-----------|
| Code | Color | Wattage | Battery | Led number | Lumen | Pcs/Carton | Ean Code |
| LTP35VE | Verde scuro | 3W | 3,7V 4000mAh Li-ion | 2700/4500/6000K | 210/240 lm | 12 | ...124071 |
| LTP35BL | Blu | 3W | 3,7V 4000mAh Li-ion | 2700/4500/6000K | 210/240 lm | 12 | ...124088 |
| LTP35PA | Beige | 3W | 3,7V 4000mAh Li-ion | 2700/4500/6000K | 210/240 lm | 12 | ...124095 |
| LTP35OC | Ocra | 3W | 3,7V 4000mAh Li-ion | 2700/4500/6000K | 210/240 lm | 12 | ...124101 |
| LTP35CU | Cuoio | 3W | 3,7V 4000mAh Li-ion | 2700/4500/6000K | 210/240 lm | 12 | ...124118 |

LED Table Lamp



Accessorio incluso
Cavo USB di tipo C
da 100 cm
Accessory included
100 cm Type C USB
cable

Egan



Rechargeable LED Lamp

Consumer Line



RGB+White

Corpo in metallo e plastica

Metal + plastic body

Batteria 3,7V 2000mAh agli ioni di litio

1 x 3,7V 2000mAh Li-ion battery

Durata: 3 ore bianco - 7,5 ore RGB

Duration: 3h white - 7,5h RGB

Tempo di ricarica: 6 ore via USB - 8 ore via pannello solare

Charging Time: 6h USB charging - 8h Solar

Cavo di ricarica USB-C, 200 cm

200 cm Type C USB cable

Grado di protezione IP65

IP65 protection

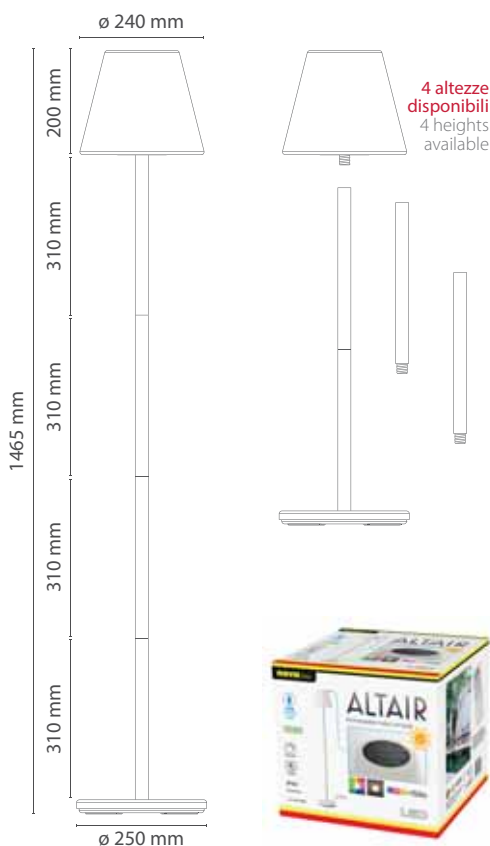

| Codice | Colore | Potenza | Batteria | Pannello solare | Led | Lumen | Imballo/Pz | 8028274 |
|---------|--------|---------|---------------------|-----------------------|-------------|--------|-------------|-----------|
| Code | Color | Wattage | Battery | Solar panel | Led | Lumen | Pcs/Cartron | Ean Code |
| LSP150W | Bianco | 3W | 3,7V 2000mAh Li-ion | 6V 1,2 W Polycrystal. | RGB + White | 150 lm | 2 | ...123623 |
| LSP150B | Nero | 3W | 3,7V 2000mAh Li-ion | 6V 1,2 W Polycrystal. | RGB + White | 150 lm | 2 | ...123616 |

Rechargeable Solar Led lamp

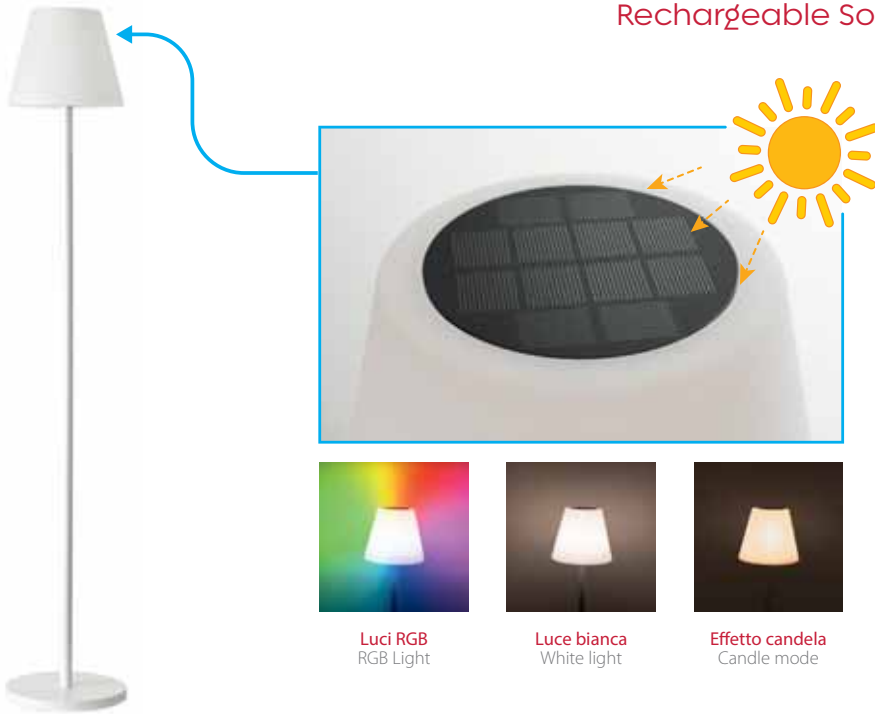

Luci RGB
RGB Light

Luce bianca
White light

Effetto candela
Candle mode

ALTAIR



Accessorio incluso
Cavo USB di tipo C
da 200 cm
Accessory included
200 cm Type C USB
cable



Telecomando per la
selezione delle funzioni
Remote control for
selecting functions



High Efficiency LED Filament

Clear

Assenza rischi fotobiologici

No photobiological risk

EN 62471



LFHG

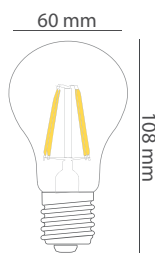

HIGH EFFICIENCY



Classe energetica A
Energy Class A



| Codice | Potenza | Base | Tensione | Corrente | Classe En. | Equivalenza | CCT | Lumen | Imballo/Pz | 8028274 |
|-----------------|---------|------|-----------|----------|--------------|-------------|-------|--------|-------------|-----------|
| Code | Wattage | base | Voltage | Current | Energy Class | Equivalence | CCT | Lumen | Pcs/ Carton | Ean Code |
| LFHG60N | 4W | E27 | 220-240 V | 30 mA | A | 60 W | 4000K | 840lm | 10/100 | ...123296 |
| LFHG75N | 5W | E27 | 220-240 V | 43 mA | A | 75 W | 4000K | 1055lm | 10/100 | ...123302 |
| LFHG100N | 7W | E27 | 220-240 V | 54 mA | A | 100 W | 4000K | 1521lm | 10/100 | ...123319 |

High Efficiency LED Filament

Clear

Assenza rischi fotobiologici

No photobiological risk

EN 62471



LFHL



LFHS

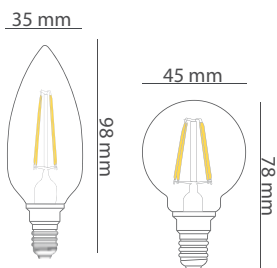

HIGH EFFICIENCY



Classe energetica C
Energy Class C



| Codice | Potenza | Base | Tensione | Corrente | Classe En. | Equivalenza | CCT | Lumen | Imballo/Pz | 8028274 |
|---------|---------|------|-----------|----------|--------------|-------------|-------|--------|-------------|-----------|
| Code | Wattage | base | Voltage | Current | Energy Class | Equivalence | CCT | Lumen | Pcs/ Carton | Ean Code |
| LFHL75N | 6W | E14 | 220-240 V | 41 mA | C | 70 W | 4000K | 1000lm | 10/100 | ...123333 |
| LFHS75N | 6W | E14 | 220-240 V | 41 mA | C | 70 W | 4000K | 1000lm | 10/100 | ...123326 |

G45 LED Miniglobe Multipack

Classic

Assenza rischi fotobiologici

No photobiological risk

EN 62471

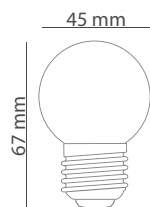

| Codice | Colore | Potenza | Corrente | Base | Tensione | Imballo/Pz | 8028274 |
|---------|---------------|---------|----------|------|-----------|------------|-----------|
| Code | Color | Wattage | Current | base | Voltage | Pcs/Carton | Ean Code |
| LC10W | Bianco/White | 1W | 5 mA | E27 | 220-230 V | 10 | ...123524 |
| LC10G | Verde/Green | 1W | 5 mA | E27 | 220-230 V | 10 | ...123531 |
| LC10B | Blu/Blue | 1W | 5 mA | E27 | 220-230 V | 10 | ...123562 |
| LC10R | Rosso/Red | 1W | 5 mA | E27 | 220-230 V | 10 | ...123548 |
| LC10Y | Giallo/Yellow | 1W | 5 mA | E27 | 220-230 V | 10 | ...123555 |
| LC10MIX | Mix | 1W | 5 mA | E27 | 220-230 V | 10 | ...123579 |

SPINE

Domestico

Corpo in polimero
Fermacavo a vite
Passacavo

Normative

CEI 23-50
CEI 23-121



Cod. CE10B / CE910E



Cod. CE10N / CE910NE



Cod. CE11B / CE911E



Cod. CE11N / CE911NE

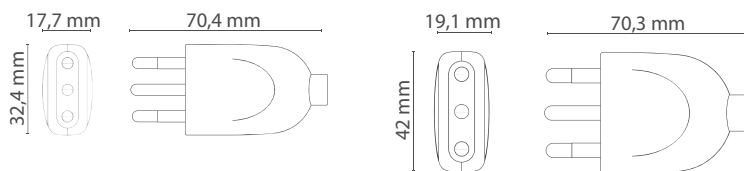

Confezionato
in box espositivo

| Codice | Colore | Spina | Presca | Tensione | Confezione | Imballo/Pz | 8028274 |
|---------|--------|----------------|--------|----------|------------|------------|-----------|
| CE10B | Bianco | 2 Poli + T 10A | - | 250 V~ | C-Box | 10/100 | ...123708 |
| CE10N | Nero | 2 Poli + T 10A | - | 250 V~ | C-Box | 10/100 | ...123715 |
| CE910E | Bianco | 2 Poli + T 10A | - | 250 V~ | Sfuso EAN | 30/240 | ...123098 |
| CE910NE | Nero | 2 Poli + T 10A | - | 250 V~ | Sfuso EAN | 30/240 | ...123104 |
| CE11B | Bianco | 2 Poli + T 16A | - | 250 V~ | C-Box | 10/100 | ...123722 |
| CE11N | Nero | 2 Poli + T 16A | - | 250 V~ | C-Box | 10/100 | ...123739 |
| CE911E | Bianco | 2 Poli + T 16A | - | 250 V~ | Sfuso EAN | 30/240 | ...123111 |
| CE911NE | Nero | 2 Poli + T 16A | - | 250 V~ | Sfuso EAN | 30/240 | ...123128 |

SPINE

Domestico

Corpo in polimero
Fermacavo a vite
Passacavo

Normative

CEI 23-50
CEI 23-121



Cod. CE12B



Cod. CE12N



Cod. CE16B



Cod. CE16N

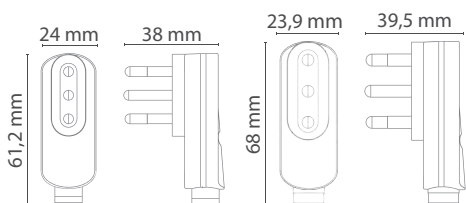

| Codice | Colore | Spina | Presca | Tensione | Confezione | Imballo/Pz | 8028274 |
|--------|--------|----------------|--------|----------|------------|------------|-----------|
| CE12B | Bianco | 2 Poli + T 10A | - | 250 V~ | Blister | 10/100 | ...123746 |
| CE12N | Nero | 2 Poli + T 10A | - | 250 V~ | Busta | 10/100 | ...123753 |
| CE16B | Bianco | 2 Poli + T 16A | - | 250 V~ | Blister | 10/100 | ...123807 |
| CE16N | Nero | 2 Poli + T 16A | - | 250 V~ | Busta | 10/100 | ...123814 |

SPINE

Domestico

Corpo in polimero
Fermacavo a vite
Passacavo

Normative

CEI 23-50
CEI 23-121



Cod. CE212B



Cod. CE212N



Cod. CE216B



Cod. CE216N

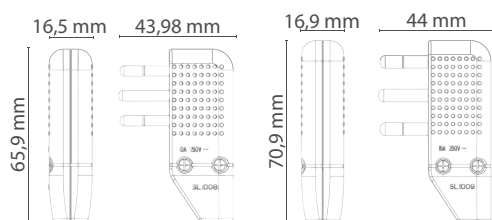

| Codice | Colore | Spina | Presca | Tensione | Confezione | Imballo/Pz | 8028274 |
|--------|--------|----------------|--------|----------|------------|------------|-----------|
| CE212B | Bianco | 2 Poli + T 10A | - | 250 V~ | C-Box | 10/100 | ...124125 |
| CE212N | Nero | 2 Poli + T 16A | - | 250 V~ | C-Box | 10/100 | ...124132 |
| CE216B | Bianco | 2 Poli + T 10A | - | 250 V~ | C-Box | 10/100 | ...124149 |
| CE216N | Nero | 2 Poli + T 16A | - | 250 V~ | C-Box | 10/100 | ...124156 |

PRESE

Domestico

Corpo in polimero
Fermacavo a vite
Passacavo

Normative
CEI 23-50
CEI 23-121



Cod. CE44B



Cod. CE44N



Cod. CE15B / CE915E



Cod. CE15N / CE915NE

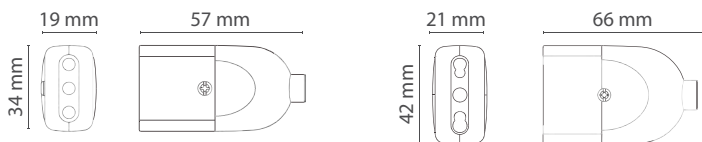

Confezionato
in box espositivo

| Codice | Colore | Spina | Presa | Tensione | Confezione | Imballo/Pz | 8028274 |
|---------|--------|-------|------------|----------|------------|------------|-----------|
| CE44B | Bianco | - | 10A + T | 250 V~ | C-Box | 10/100 | ...123760 |
| CE44N | Nero | - | 10A + T | 250 V~ | C-Box | 10/100 | ...123777 |
| CE15B | Bianco | - | 10/16A + T | 250 V~ | C-Box | 10/100 | ...123784 |
| CE15N | Nero | - | 10/16A + T | 250 V~ | C-Box | 10/100 | ...123791 |
| CE915E | Bianco | - | 10/16A + T | 250 V~ | Sfuso EAN | 30/240 | ...123166 |
| CE915NE | Nero | - | 10/16A + T | 250 V~ | Sfuso EAN | 30/240 | ...123173 |

SPINE e PRESE

Domestico

Corpo in polimero
Fermacavo a vite
Passacavo

Normative
CEI 23-50
CEI 23-121



KIT
Cod. CE27B



KIT
Cod. CE28B



KIT
Cod. CE27N



KIT
Cod. CE28N

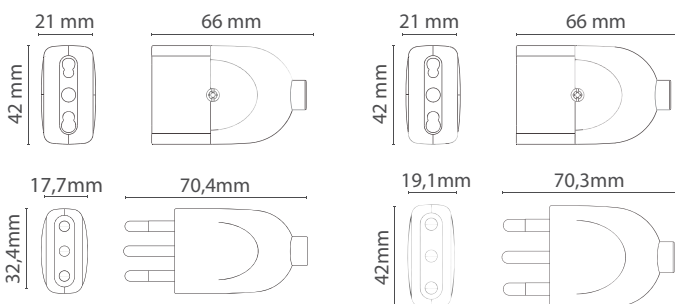

| Codice | Colore | Spina | Presca | Tensione | Confezione | Imballo/Pz | 8028274 |
|--------|--------|----------------|------------|----------|------------|------------|-----------|
| CE27B | Bianco | 2 Poli + T 10A | 10/16A + T | 250 V~ | C-Box | 10/100 | ...123821 |
| CE27N | Nero | 2 Poli + T 10A | 10/16A + T | 250 V~ | C-Box | 10/100 | ...123838 |
| CE28B | Bianco | 2 Poli + T 16A | 10/16A + T | 250 V~ | C-Box | 10/100 | ...123845 |
| CE28N | Nero | 2 Poli + T 16A | 10/16A + T | 250 V~ | C-Box | 10/100 | ...123852 |

SPINE e PRESE



Domestico

Corpo in polimero
Fermacavo a vite
Passacavo

Normative

CEI 23-50
CEI 23-121



Cod. CE36B / CE36E



Cod. CE36N / 36NE



Cod. CE45B / CE45E



Cod. CE45N / CE45NE

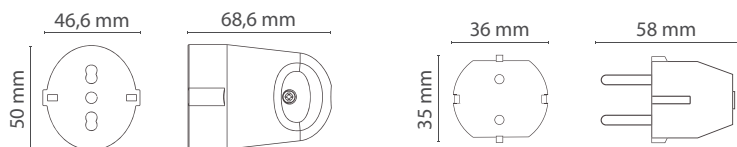

Confezionato
in box espositivo

| Codice | Colore | Spina | Presa | Tensione | Confezione | Imballo/Pz | 8028274 |
|--------|--------|---------------------|-------------------|----------|------------|------------|-----------|
| CE36B | Bianco | - | Schuko 10/16A + T | 250 V~ | C-Box | 10/90 | ...123661 |
| CE36N | Nero | - | Schuko 10/16A + T | 250 V~ | C-Box | 10/90 | ...123678 |
| CE36E | Bianco | - | Schuko 10/16A + T | 250 V~ | Sfuso EAN | 25/200 | ...123050 |
| CE36NE | Nero | - | Schuko 10/16A + T | 250 V~ | Sfuso EAN | 25/200 | ...123067 |
| CE45B | Bianco | Schuko 2 Poli+T 16A | - | 250 V~ | C-Box | 10/90 | ...123685 |
| CE45N | Nero | Schuko 2 Poli+T 16A | - | 250 V~ | C-Box | 10/90 | ...123692 |
| CE45E | Bianco | Schuko 2 Poli+T 16A | - | 250 V~ | Sfuso EAN | 25/200 | ...123074 |
| CE45NE | Nero | Schuko 2 Poli+T 16A | - | 250 V~ | Sfuso EAN | 25/200 | ...123081 |

ADATTATORI

Domestico

Corpo in polimero

Normative

CEI 23-57



Cod. CE480B



Cod. CE480N

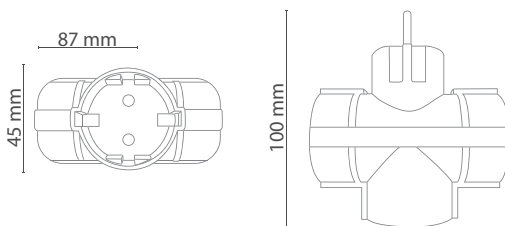

| Codice | Colore | Spina | Presca | Tensione | Confezione | Imballo/Pz | 8028274 |
|--------|--------|--------|------------|----------|------------|------------|-----------|
| CE480B | Bianco | Schuko | 3 x Schuko | 250 V~ | C-Box | 10/80 | ...123906 |
| CE480N | Nero | Schuko | 3 x Schuko | 250 V~ | C-Box | 10/80 | ...123913 |

ADATTATORI

Domestico

Corpo in polimero

Normative

CEI 23-57



Cod. CE47B



Cod. CE47N

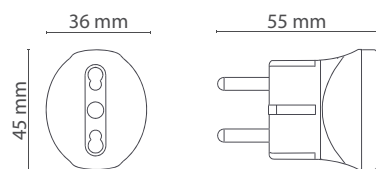

| Codice | Colore | Spina | Presa | Tensione | Confezione | Imballo/Pz | 8028274 |
|--------|--------|--------|------------|----------|------------|------------|-----------|
| CE47B | Bianco | Schuko | 10/16A + T | 250 V~ | C-Box | 10/90 | ...123883 |
| CE47N | Nero | Schuko | 10/16A + T | 250 V~ | C-Box | 10/90 | ...123890 |

ADATTATORI Multipli

Domestico

Corpo in polimero

Normative
CEI 23-57



Cod. CE49B



Cod. CE49N

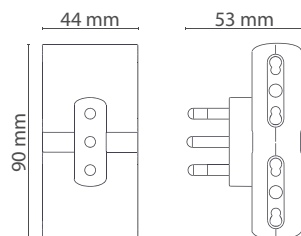

| Codice | Colore | Spina | Presca | Tensione | Confezione | Imballo/Pz | 8028274 |
|--------|--------|----------------|--------------|----------|------------|------------|-----------|
| CE49B | Bianco | 2 Poli + T 16A | 4x10/16A + T | 250 V~ | C-Box | 10/100 | ...123869 |
| CE49N | Nero | 2 Poli + T 16A | 4x10/16A + T | 250 V~ | C-Box | 10/100 | ...123876 |

ADATTATORI



Domestico

Corpo in polimero

Normative
CEI 23-57



Cod. CE13B / CE913E



Cod. CE13N / CE913NE



Cod. CE17B / CE917E



Cod. CE17N / CE917NE

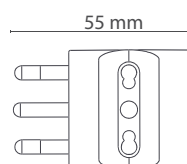
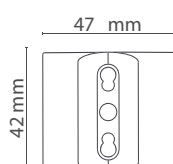
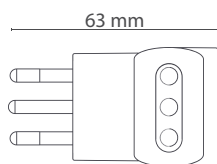
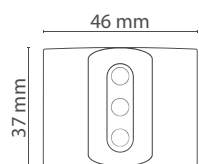

Confezionato
in box espositivo

| Codice | Colore | Spina | Presca | Tensione | Confezione | Imballo/Pz | 8028274 |
|---------|--------|----------------|---------------------|----------|------------|------------|-----------|
| CE13B | Bianco | 2 Poli + T 10A | 3x2 Poli + T 10A | 250 V~ | C-Box | 10/120 | ...123920 |
| CE13N | Nero | 2 Poli + T 10A | 3x2 Poli + T 10A | 250 V~ | C-Box | 10/120 | ...123937 |
| CE913E | Bianco | 2 Poli + T 10A | 3x2 Poli + T 10A | 250 V~ | Sfuso EAN | 30/240 | ...123135 |
| CE913NE | Nero | 2 Poli + T 10A | 3x2 Poli + T 10A | 250 V~ | Sfuso EAN | 30/240 | ...123142 |
| CE17B | Bianco | 2 Poli + T 16A | 3x2 Poli + T 10/16A | 250 V~ | C-Box | 10/120 | ...123968 |
| CE17N | Nero | 2 Poli + T 16A | 3x2 Poli + T 10/16A | 250 V~ | C-Box | 10/120 | ...123975 |
| CE917E | Bianco | 2 Poli + T 16A | 3x2 Poli + T 10/16A | 250 V~ | Sfuso EAN | 30/240 | ...123180 |
| CE917NE | Nero | 2 Poli + T 16A | 3x2 Poli + T 10/16A | 250 V~ | Sfuso EAN | 30/240 | ...123197 |

ADATTATORI

Domestico

Corpo in polimero

Normative
CEI 23-57



Cod. CE37B / CE37E



Cod. CE37N / CE937NE



Cod. CE38B / CE938E



Cod. CE38N / CE938NE

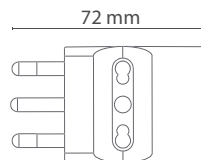
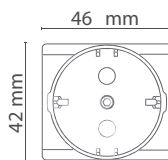
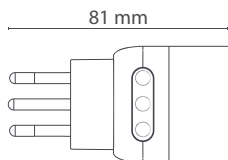
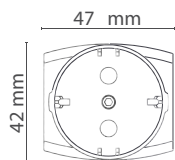

Confezionato
in box espositivo

| Codice | Colore | Spina | Presca | Tensione | Confezione | Imballo/Pz | 8028274 |
|---------|--------|----------------|-------------------------------|----------|------------|------------|-----------|
| CE37B | Bianco | 2 Poli + T 10A | 2x2 Poli + T 10A, 1xSchuko | 250 V~ | C-Box | 10/100 | ...124002 |
| CE37N | Nero | 2 Poli + T 10A | 2x2 Poli + T 10A, 1xSchuko | 250 V~ | C-Box | 10/100 | ...011654 |
| CE937E | Bianco | 2 Poli + T 10A | 2x2 Poli + T 10A, 1xSchuko | 250 V~ | Sfuso EAN | 25/200 | ...122367 |
| CE937NE | Nero | 2 Poli + T 10A | 2x2 Poli + T 10A, 1xSchuko | 250 V~ | Sfuso EAN | 25/200 | ...123210 |
| CE38B | Bianco | 2 Poli + T 16A | 2x2 Poli + T 10/16A, 1xSchuko | 250 V~ | C-Box | 10/100 | ...124026 |
| CE38N | Nero | 2 Poli + T 16A | 2x2 Poli + T 10/16A, 1xSchuko | 250 V~ | C-Box | 10/100 | ...011661 |
| CE938E | Bianco | 2 Poli + T 16A | 2x2 Poli + T 10/16A, 1xSchuko | 250 V~ | Sfuso EAN | 25/200 | ...121605 |
| CE938NE | Nero | 2 Poli + T 16A | 2x2 Poli + T 10/16A, 1xSchuko | 250 V~ | Sfuso EAN | 25/200 | ...123227 |

ADATTATORI



Domestico

Corpo in polimero

Normative

CEI 23-57



Cod. CE14B / CE914E



Cod. CE14N / CE914NE



Cod. CE18B / CE918E



Cod. CE18N / CE918NE

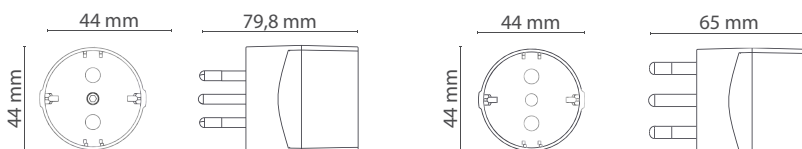

Confezionato
in box espositivo

| Codice | Colore | Spina | Presca | Tensione | Confezione | Imballo/Pz | 8028274 |
|---------|--------|----------------|--------|----------|------------|------------|-----------|
| CE14B | Bianco | 2 Poli + T 10A | Schuko | 250 V~ | C-Box | 30/240 | ...123944 |
| CE14N | Nero | 2 Poli + T 10A | Schuko | 250 V~ | C-Box | 30/240 | ...011678 |
| CE914E | Bianco | 2 Poli + T 10A | Schuko | 250 V~ | Sfuso EAN | 30/240 | ...121582 |
| CE914NE | Nero | 2 Poli + T 10A | Schuko | 250 V~ | Sfuso EAN | 30/240 | ...123159 |
| CE18B | Bianco | 2 Poli + T 16A | Schuko | 250 V~ | C-Box | 30/240 | ...123982 |
| CE18N | Nero | 2 Poli + T 16A | Schuko | 250 V~ | C-Box | 30/240 | ...123999 |
| CE918E | Bianco | 2 Poli + T 16A | Schuko | 250 V~ | Sfuso EAN | 30/240 | ...121599 |
| CE918NE | Nero | 2 Poli + T 16A | Schuko | 250 V~ | Sfuso EAN | 30/240 | ...123203 |

ADATTATORI Salvaspazio

Domestico

Corpo in polimero

Normative
CEI 23-57



Cod. CE214B



Cod. CE214N



Cod. CE238B



Cod. CE238N

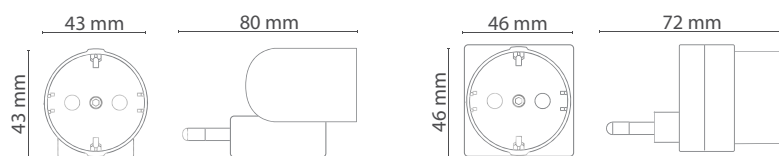

| Codice | Colore | Spina | Presa | Tensione | Confezione | Imballo/Pz | 8028274 |
|--------|--------|----------------|------------------------|----------|------------|------------|-----------|
| CE214B | Bianco | 2 Poli + T 10A | 1xSchuko | 250 V~ | C-Box | 10/100 | ...124187 |
| CE214N | Nero | 2 Poli + T 10A | 1xSchuko | 250 V~ | C-Box | 10/100 | ...124194 |
| CE238B | Bianco | 2 Poli + T 16A | 1xSchuko, 2x10/16A + T | 250 V~ | C-Box | 10/100 | ...124200 |
| CE238N | Nero | 2 Poli + T 16A | 1xSchuko, 2x10/16A + T | 250 V~ | C-Box | 10/100 | ...124217 |

PORTALAMPADE

Domestico

Portalamпада con ghiera
Cappuccio con entrata filettata sagomata
Morsetti e contatti in ottone
Corpo in camicia parzialmente
filettata con battuta fermaparalume

Normative

CEI EN 60838



Cod. CE103E

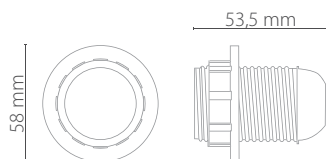

Confezionato
in box espositivo

| Codice | Attacco | Tensione | Colore | Confezione | Imballo/Pz | 8028274 |
|--------|----------------|------------|--------|------------|------------|-----------|
| CE103E | E27 con ghiera | 250 V~, 4A | Bianco | Sfuso EAN | 15/120 | ...124170 |

MORSETTI

Domestico

Supporto con viti sfuso

Normative
CEI 23-21

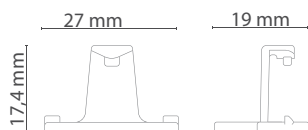

| Codice | n° Pz/Conf | Confezione | Imballo/Pz | 8028274 |
|--------|------------|------------|------------|-----------|
| SVP43 | 10 | Busta | 1 | ...123586 |



www.novaline.it
info@novaline.it

